

Diritti riservati All rights reserved

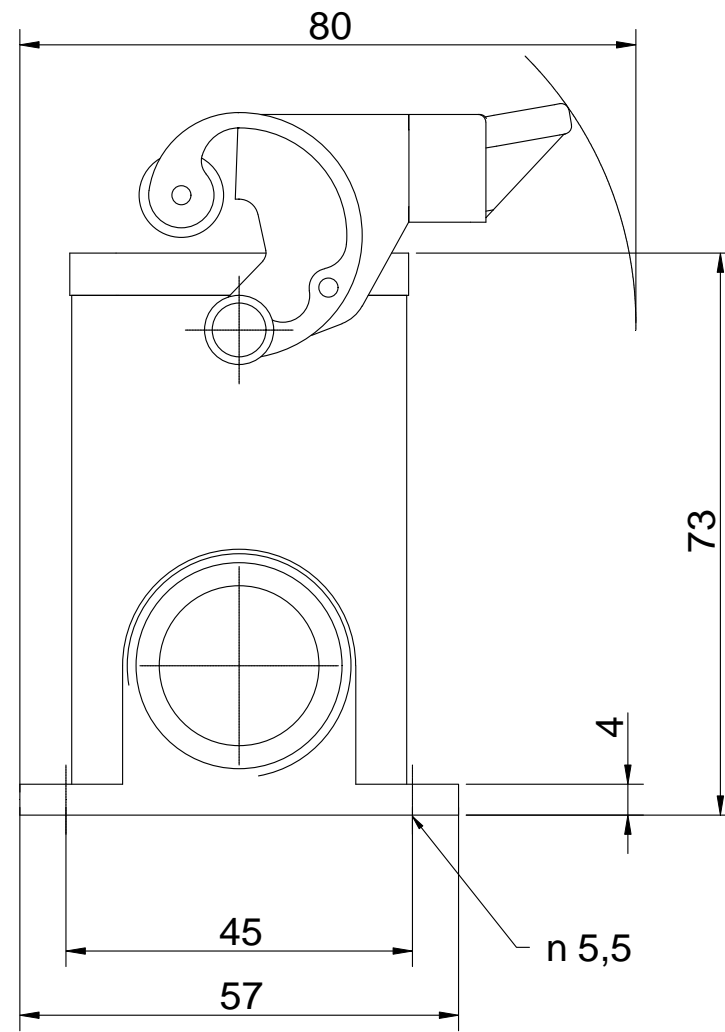
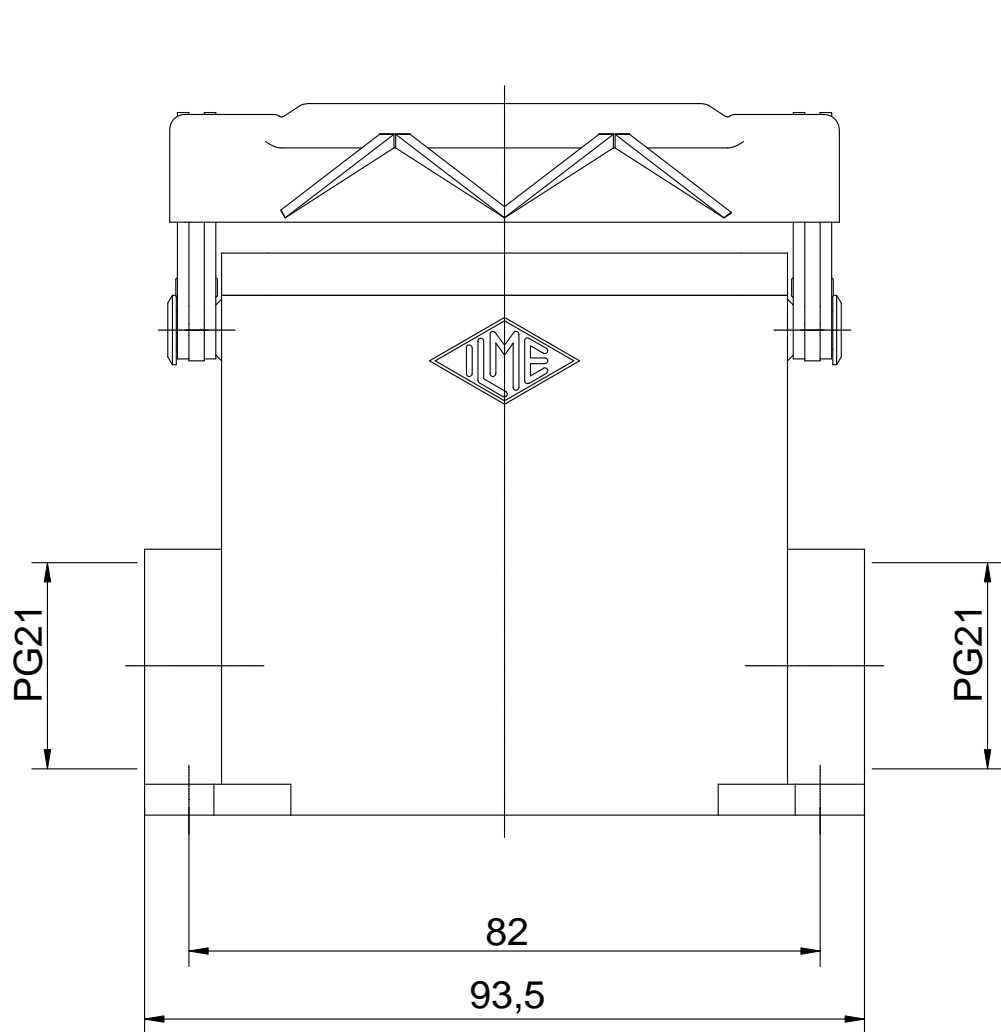

Date 10.01.2007	CMAP 03 L2		Scale
Sign.	surface mounting h. 1 lev. 2xPG21 ins.		1:1
			